

12-NEIGHBOUR PACKINGS OF UNIT BALLS IN \mathbb{E}^3

K. BÖRÖCZKY¹ and L. SZABÓ^{2,*}

¹Department of Geometry, Eötvös Loránd University, 1117 Budapest, Pázmány Péter sétány 1/c,
Hungary
e-mail: kar.boroczky@gmail.com

²Institute of Informatics and Economics, University of West-Hungary, 9400 Sopron,
Bajcsy-Zsilinszky utca 9, Hungary
e-mail: lszabo@inf.nyme.hu

(Received August 28, 2014; revised March 20, 2015; accepted March 30, 2015)

Abstract. We prove that any 12-neighbour packing of unit balls in \mathbb{E}^3 is composed of parallel layers of the same hexagonal structure as the layers in the densest lattice packing.

1. Introduction

Problems whose solutions satisfy certain regularity properties are particularly interesting in discrete geometry. In this paper we deal with one such problem. A packing of unit balls in \mathbb{E}^3 is said to be a 12-neighbour packing if each ball is touched by 12 others. A 12-neighbour packing of unit balls can be constructed as follows. Consider a horizontal hexagonal layer of unit balls (in which the centres of the balls are coplanar and each ball is touched by six others). Put on the top of this layer a second horizontal hexagonal layer of unit balls so that each ball of the first layer touches three balls of the second layer. The translation which carries the first layer into the second one, carries the second layer into a third one, and repeated translations of the same kind in both directions produce a lattice packing of unit balls (in fact, the densest lattice packing of unit balls) in which each ball has 12 neighbours.

Observe that the translation that carries the first layer into the second one carries the balls of the second layer just over the hollows of the first layer. However, we can also put the balls of the third layer above the balls of the

* Corresponding author.

Key words and phrases: discrete geometry, 12-neighbour packings, Fejes Tóth's conjecture.

Mathematics Subject Classification: 52C17.

first layer so that the first and the third layers are symmetric with respect to the plane of the centres of the balls of the second layer. Repeated reflections of the same kind produce another 12-neighbour packing of unit balls different from the previous one. In fact, one can produce infinitely many different 12-neighbour packings of unit balls by changing the positions of the parallel hexagonal layers relative to each other. Note that the symmetry group of any such packing contains the translation group of a hexagonal layer and the group of rotations of 120° around the lines perpendicular to a hexagonal layer carrying this layer into itself.

László Fejes Tóth [4,5] conjectured that any 12-neighbour packing of unit balls in \mathbb{E}^3 is composed of hexagonal layers. In September 2012 Thomas Hales posted a paper on the preprint server arXiv with a computer-assisted proof of this conjecture (see [6]). The aim of this paper is to give a more transparent proof of the conjecture along a different line.

THEOREM 1. *Any 12-neighbour packing of unit balls in \mathbb{E}^3 is composed of hexagonal layers.*

2. Proof of Theorem 1

László Fejes Tóth noted that the first step in a possible proof of his conjecture might be to give a lower bound for the distance of two non-neighbouring balls of a 12-neighbour packing of unit balls. It turns out that this problem is closely related to the Tammes problem for 13 points on \mathbb{S}^2 . Let a_{13} denote the maximum number with the property that one can place 13 points on \mathbb{S}^2 so that the spherical distance between any two different points is at least a_{13} . The first upper bound for a_{13} smaller than 60° was given in [2] by the authors of the present paper. This bound has been slightly improved in [1] by Christine Bachoc and Frank Vallentin. Recently, combining geometric arguments with the power of modern computers, Oleg Musin and Alexey Tarasov [7] succeeded in determining the exact value of a_{13} .

THEOREM 2. $a_{13} = 57.13670307\dots^\circ$.

Based on this result we can give a pure geometric proof of Theorem 1. The organization of the proof is as follows. First we give a lower bound on the distance of non-neighbouring balls in a 12-neighbour packing. Then we prove some simple properties of the systems of touching points on a given ball with its neighbours. The main and most technical part of the proof is to show that, up to isometry, there are only two configurations of the touching points on a given ball satisfying the above properties. Using this, we complete the proof that a 12-neighbour packing is composed of hexagonal layers.

Set $a_0 = 57.13670309^\circ$. Note that $a_0 > a_{13}$.

THEOREM 3. *Let B_0, B_1, \dots, B_{13} be fourteen different members of a packing of unit balls in \mathbb{E}^3 . Assume that each of the balls B_1, B_2, \dots, B_{12} touches the ball B_0 . Then the distance between the centres of B_0 and B_{13} is at least*

$$4 \sin \left(180^\circ \left(\frac{60^\circ}{a_0} - \frac{5}{6} \right) \right) = 2.51838585 \dots$$

PROOF. The same argument that we used in the proof of Theorem 2 in [2] yields the lower bound

$$4 \sin \left(180^\circ \left(\frac{60^\circ}{a_0} - \frac{5}{6} \right) \right)$$

for the distance between the centres of B_0 and B_{13} . \square

COROLLARY 1. *The distance between the centres of any two non-neighbouring balls in a 12-neighbour packing of unit balls in \mathbb{E}^3 is at least*

$$4 \sin \left(180^\circ \left(\frac{60^\circ}{a_0} - \frac{5}{6} \right) \right) = 2.51838585 \dots$$

Set

$$y(x) = 4 \sin \left(180^\circ \left(\frac{60^\circ}{x} - \frac{5}{6} \right) \right),$$

and consider the triangle with side lengths 2, 2, and $y(x)$. Straightforward calculation shows that the angle of this triangle opposite the side of length $y(x)$ is

$$b(x) = 2 \cdot 180^\circ \left(\frac{60^\circ}{x} - \frac{5}{6} \right).$$

Set $b_0 = 78.04071344^\circ$. Then

$$b(a_{13}) > b(a_0) = 78.04071344 \dots^\circ > b_0.$$

Furthermore, set $r_0 = (180^\circ - b_0)/2 = 50.97964328^\circ$.

COROLLARY 2. *Let B_0, B_1, \dots, B_{12} be thirteen different members of a 12-neighbour packing of unit balls in \mathbb{E}^3 . Assume that each of the balls B_1, B_2, \dots, B_{12} touches the ball B_0 . Let P_1, P_2, \dots, P_{12} denote the twelve points at which B_1, B_2, \dots, B_{12} touch B_0 , respectively. Then, regarding $\mathcal{P} = \{P_1, P_2, \dots, P_{12}\}$ as a point set on \mathbb{S}^2 ,*

(i) *the distance between any two different points of \mathcal{P} is either 60° or at least b_0 ,*

(ii) *the radius of any circle whose interior does not contain any point of \mathcal{P} is smaller than r_0 .*

PROOF. (i) Let, say, P_1 and P_2 be two points of \mathcal{P} whose distance is greater than 60° . Then B_1 and B_2 do not touch each other, hence, by Corollary 1, the distance between their centres is at least $y(a_0)$. Now consider the triangle whose vertices are the centres O , O_1 and O_2 of the balls B_0 , B_1 and B_2 , respectively. In this triangle $OO_1 = OO_2 = 2$ and $O_1O_2 \geq y(a_0)$, hence $\angle O_1OO_2 \geq b(a_0) > b_0$ and thus $\angle P_1OP_2 > b_0$.

(ii) It is enough to prove that the radius of any circle whose interior does not contain any point of \mathcal{P} and whose boundary contains at least three points of \mathcal{P} is smaller than r_0 . Consider a circle κ whose interior does not contain any point of \mathcal{P} and whose boundary contains at least three points of \mathcal{P} . Let, say, P_1, P_2 and P_3 be three points of \mathcal{P} lying on the boundary of κ . Let B'_0 be the image of B_0 under the reflection through the plane spanned by the centres of B_1, B_2 and B_3 . Since B'_0 does not overlap B_1, B_2, \dots, B_{12} , therefore, by Theorem 3, the distance between the centres of B_0 and B'_0 is at least $y(a_0)$. Now consider the triangle whose vertices are the centres O , O' and O_1 of the balls B_0, B'_0 and B_1 , respectively (see Fig. 1).

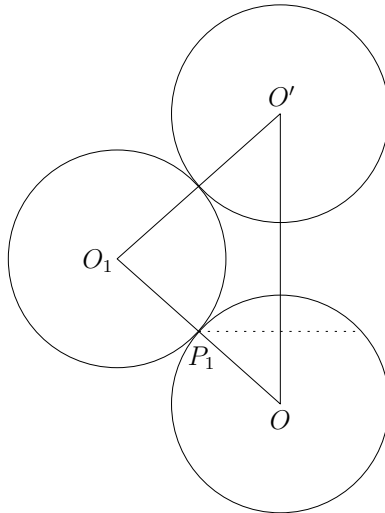

Fig. 1

In this triangle $OO_1 = O'O_1 = 2$ and $OO' \geq y(a_0)$, hence $\angle OO_1O' \geq b(a_0)$ and thus $\angle O_1OO' \leq (180^\circ - b(a_0))/2 < (180^\circ - b_0)/2 = r_0$. Consequently $\angle P_1OO' < r_0$. Taking into account that the centre of κ lies on OO' , the assertion follows. \square

Let \mathcal{C} be the vertex set of the Archimedean tiling $(3, 4, 3, 4)$ of \mathbb{S}^2 . Now, there exist six points of \mathcal{C} lying on a great circle, say, ℓ of \mathbb{S}^2 . Replace the

three points of \mathcal{C} lying in one of the open hemispheres bounded by ℓ with the images of the three points of \mathcal{C} lying in the other open hemisphere bounded by ℓ under the reflection through ℓ . Let \mathcal{C}' be the point set obtained in this way from \mathcal{C} .

THEOREM 4. *Let \mathcal{P} be a set of 12 points on \mathbb{S}^2 such that*

- *the distance between any two different points of \mathcal{P} is either 60° or at least b_0 ,*
- *the radius of any circle whose interior does not contain any point of \mathcal{P} is smaller than r_0 .*

Then \mathcal{P} is congruent to either \mathcal{C} or \mathcal{C}' .

We will prove Theorem 4 in the subsequent sections. Using Theorem 4 the proof of Theorem 1 can be completed as follows. Let \mathcal{B} be a 12-neighbour packing of unit balls in \mathbb{E}^3 and consider the Dirichlet–Voronoi cell decomposition of \mathbb{E}^3 associated to \mathcal{B} . Note that the Dirichlet–Voronoi cells are convex polyhedra which form a face-to-face tiling of \mathbb{E}^3 .

COROLLARY 3. *Let B_0 be a unit ball of \mathcal{B} . Then the Dirichlet–Voronoi cell of B_0 is either a rhombic dodecahedron or a trapezo-rhombic dodecahedron circumscribed about B_0 .*

PROOF. Let B_1, B_2, \dots, B_{12} denote the twelve neighbours of B_0 in \mathcal{B} and let $O, O_1, O_2, \dots, O_{12}$ be the centres of $B_0, B_1, B_2, \dots, B_{12}$, respectively. Let P_1, P_2, \dots, P_{12} denote the twelve points at which B_1, B_2, \dots, B_{12} touch B_0 , respectively. Regarding $\mathcal{P} = \{P_1, P_2, \dots, P_{12}\}$ as a point set on \mathbb{S}^2 , then, by Theorem 4, \mathcal{P} is congruent to either \mathcal{C} or \mathcal{C}' . Consider the intersection of the twelve half spaces bounded by the twelve tangent planes of B_0 at the points of \mathcal{P} and containing B_0 and denote this polyhedron by \mathcal{V} . It is easy to see that \mathcal{V} is a rhombic dodecahedron circumscribed about B_0 if \mathcal{P} is congruent to \mathcal{C} and \mathcal{V} is a trapezo-rhombic dodecahedron circumscribed about B_0 if \mathcal{P} is congruent to \mathcal{C}' (see Fig. 2).

Let \mathcal{DV} denote the Dirichlet–Voronoi cell of B_0 . Obviously, \mathcal{DV} is contained in \mathcal{V} . To prove that $\mathcal{DV} = \mathcal{V}$ it is enough to show that each vertex of \mathcal{V} is a vertex of \mathcal{DV} , as well. Let X be a vertex of \mathcal{V} . It is known that X is a vertex of \mathcal{DV} if and only if the ball Γ with centre X and of radius XO does not contain any point of the set of the centres of the balls of \mathcal{B} in its interior and contains at least four points of the set of the centres of the balls of \mathcal{B} spanning \mathbb{E}^3 on its boundary.

Since Γ contains O and at least three additional points among O_1, O_2, \dots, O_{12} on its boundary, spanning together \mathbb{E}^3 , it is enough to prove that Γ does not contain any point of the set of the centres of the balls of \mathcal{B} in its interior.

First, suppose that X is a vertex of degree three. Let, say, B_1, B_2 and B_3 be the three balls of \mathcal{B} whose tangent planes incident to their touching

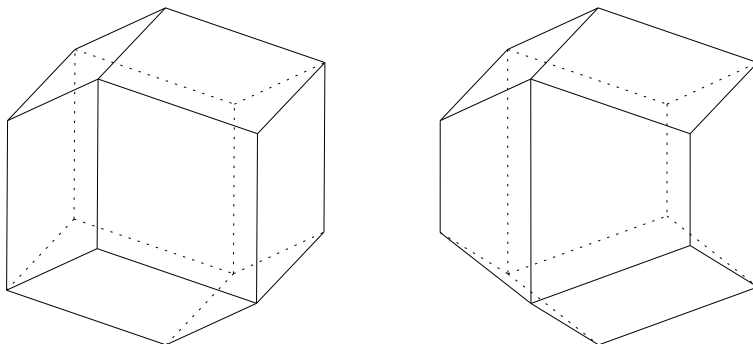

Fig. 2

points with B_0 intersect at X . Then, the points O_1, O_2, O_3 together with O form the vertices of a regular tetrahedron of side length 2 inscribed in Γ . Now, it is easy to see that the union of the interiors of the balls of radius 2 with centres O, O_1, O_2, O_3 contains every interior points of Γ , hence Γ cannot contain any point of the set of the centres of the balls of \mathcal{B} in its interior.

Next, suppose that X is a vertex of degree four. Let, say, B_1, B_2, B_3 and B_4 be the four balls of \mathcal{B} whose tangent planes incident to their touching points with B_0 intersect at X . Then, the points O_1, O_2, O_3, O_4 are the vertices of a square of side length 2 and together with O and its image O' under the reflection through the plane of O_1, O_2, O_3, O_4 they form the vertices of a regular octahedron of side length 2 inscribed in Γ . Now, it is easy to see that the union of the interiors of the balls of radius 2 with centres O, O_1, O_2, O_3, O_4 contains every interior points of Γ , hence Γ cannot contain any point of the set of the centres of the balls of \mathcal{B} in its interior. \square

If each Dirichlet–Voronoi cell is a rhombic dodecahedron, then \mathcal{B} is uniquely determined and coincides with the densest lattice packing of unit balls which consists of parallel hexagonal layers.

Now, suppose that there is a Dirichlet–Voronoi cell which is a trapezo-rhombic dodecahedron. Then there is a hexagonal layer \mathcal{L} in the Dirichlet–Voronoi cell decomposition consisting of trapezo-rhombic dodecahedra each of which is adjacent to six others along their common trapezoid faces. Note that a trapezo-rhombic dodecahedron arises by cutting a rhombic dodecahedron into two parts by a plane perpendicular to an edge of the rhombic dodecahedron and going through the centre of the ball inscribed in the rhombic dodecahedron and replacing one part by the image of the other part under the reflection through this plane. Therefore the Dirichlet–Voronoi cells adjacent to \mathcal{L} along their common rhombus faces on the same side of \mathcal{L} form either a hexagonal layer of rhombic dodecahedra or a hexagonal layer

of trapezo-rhombic dodecahedra parallel to \mathcal{L} . By repeated applications of this argument, one obtains that the Dirichlet–Voronoi cell decomposition consists of parallel hexagonal layers of rhombic dodecahedra and trapezo-rhombic dodecahedra. This implies that \mathcal{B} consists of parallel hexagonal layers of unit balls in this case, too.

3. Spherical triangles

For the reader's convenience, the following remark collects some basic facts about (convex) spherical triangles. The area of a spherical polygon S will be denoted by $|S|$.

REMARK 1. (i) Suppose that the lengths of the sides AB and AC are fixed and the angle $\angle BAC$ increases in a spherical triangle ABC . Then the side BC increases.

(ii) Suppose that the lengths of the sides AB and AC are fixed and the angle $\angle BAC$ increases in a spherical triangle ABC in which $AB \leq AC < 90^\circ$. Then the angle $\angle ABC$ decreases, furthermore, the angle $\angle ACB$ increases while $\angle ABC > 90^\circ$ and decreases while $\angle ABC < 90^\circ$.

(iii) Let ABC be a spherical triangle. Now

- $AB + BC < 180^\circ$ if and only if $\angle ACB + \angle BAC < 180^\circ$,
- $AB + BC = 180^\circ$ if and only if $\angle ACB + \angle BAC = 180^\circ$,
- $AB + BC > 180^\circ$ if and only if $\angle ACB + \angle BAC > 180^\circ$.

(iv) Suppose that the vertices A and B and the angle $\angle ABC = 90^\circ$ are fixed and the side BC increases from 0° to 180° in a spherical triangle ABC . Then the side AC increases if $AB < 90^\circ$ and decreases if $AB > 90^\circ$.

(v) Suppose that the vertices A and B and the angle $\angle ABC$ are fixed and the side BC increases in a spherical triangle ABC . Then the angle $\angle ACB$ decreases while $AC < 90^\circ$ and increases while $AC > 90^\circ$.

(vi) Let ABC be an isosceles spherical triangle with $AC = BC$. Then $\angle ACB \geq AB$ with equality if and only if $BC = 90^\circ$. Furthermore, if the vertices A and B are fixed and the sides $AC = BC$ increases in the isosceles spherical triangle ABC , then the angle $\angle ACB$ decreases while $BC < 90^\circ$ and increases while $BC > 90^\circ$.

(vii) Let ABC be a spherical triangle. Then the set of those points C' which are not separated from C by the line AB and for which $|ABC| = |ABC'|$ is the circle arc $\widehat{A'B'}$ going through C where A' and B' denote the antipodals of A and B on \mathbb{S}^2 , respectively. This circle arc is usually called the Lexell circle of the triangle ABC with respect to its side AB .

(viii) Let ABC be a spherical triangle and consider its circumscribed circle. Let C^* denote the midpoint of the arc \widehat{AB} of the circumscribed circle containing C . If we move C toward C^* on the circumscribed circle, then both $|ABC|$ and $\angle ACB$ increase.

(ix) Suppose that the vertices A and B and the length of AC are fixed and the angle $\angle BAC$ increases in a spherical triangle ABC . Then $|ABC|$ increases while the centre of the circumscribed circle of ABC lies in the interior of the hemisphere bounded by the line BC and containing ABC (i.e., $\angle ABC + \angle ACB > \angle BAC$) and decreases while the centre of the circumscribed circle of ABC lies in the interior of the hemisphere bounded by the line BC and not containing ABC (i.e., $\angle ABC + \angle ACB < \angle BAC$).

4. Delone triangles

Set $a = 60^\circ$. Let \mathcal{P} be a set of 12 points P_1, P_2, \dots, P_{12} on \mathbb{S}^2 such that

- the distance between any two different points of \mathcal{P} is either a or at least b_0 ,
- the radius of any circle whose interior does not contain any point of \mathcal{P} is smaller than r_0 .

Let \mathcal{D} be a Delone triangulation of \mathcal{P} . Note that, the Delone triangulation of a point set is not necessarily unique. The triangle faces of \mathcal{D} will be consistently referred to as Delone triangles. For $0 \leq i \leq 3$, a Delone triangle will be called of type i if it has i sides of length at least b_0 and $3 - i$ sides of length a . In this section we give bounds on the sides, angles and area of Delone triangles of different types.

For $0 \leq i \leq 3$, let $T^{(i)}$ denote the spherical triangle which has i sides of length b_0 and $3 - i$ sides of length a . For $n \geq 3$, let α_n denote the angles of the regular n -gon of side length a . It is easy to calculate the angles and the area of the triangles $T^{(0)}, T^{(1)}, T^{(2)}, T^{(3)}$. Each angle of the triangle $T^{(0)}$ is $\alpha_3 = 70.52877936\dots^\circ$, and its area is $t_0 = 31.58633809\dots^\circ$. The angle of $T^{(1)}$ opposite the side of length b_0 is $\beta_1 = 93.27018753\dots^\circ$, each of the two angles of $T^{(1)}$ adjacent to the side of length b_0 is $\beta_2 = 62.10395766\dots^\circ$ and its area is $t_1 = 37.47810285\dots^\circ$. The angle of $T^{(2)}$ opposite the side of length a is $\beta_4 = 61.47335360\dots^\circ$, each of the two angles of $T^{(2)}$ adjacent to the side of length a is $\beta_5 = 82.97566677\dots^\circ$ and its area is $t_2 = 47.42468715\dots^\circ$. Each angle of the triangle $T^{(3)}$ is $\beta_3 = 80.11633586\dots^\circ$, and its area is $t_3 = 60.34900758\dots^\circ$.

Let ABC be a spherical triangle in which $AB = BC = a$ and whose circumscribed circle is of radius r_0 . Set $\nu_1 = AC = 99.88366413\dots^\circ$.

PROPOSITION 1. *Let, say, $P_1P_2P_3$ be a Delone triangle of type 1 of \mathcal{D} in which $P_1P_2 = P_2P_3 = a$. Then*

- (i) $\beta_1/2 < \angle P_2P_1P_3 = \angle P_2P_3P_1 \leq \beta_2$,
- (ii) $\beta_1 \leq \angle P_1P_2P_3 < 2\beta_2$,
- (iii) $P_1P_3 < \nu_1$,
- (iv) *if $P_1P_3 \leq 90^\circ$, i.e., $\angle P_1P_2P_3 \leq \alpha_4$, then $P_1P_2P_3$ contains the centre of its circumscribed circle.*

PROOF. The bounds $\angle P_1P_2P_3 \geq \beta_1$ and $\angle P_2P_1P_3 = \angle P_2P_3P_1 \leq \beta_2$ follow from Remark 1(i) and (ii).

Consider the triangle P_1P_2Q in which $P_2Q = a$, the points P_3 and Q are not separated by the line P_1P_2 , and whose circumscribed circle is of radius r_0 . Let O denote the centre of the circumscribed circle of P_1P_2Q . Let M be the midpoint of the side P_1P_2 and let N be the midpoint of the side P_1Q . Set $\beta = \angle MP_2O$ (see Fig. 3).

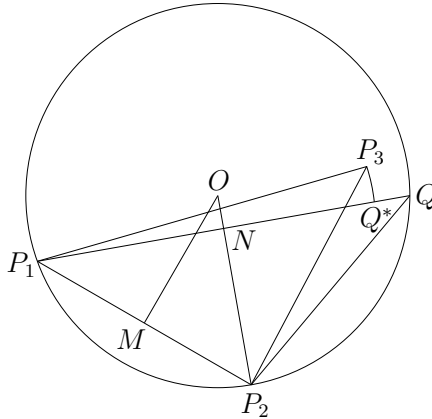

Fig. 3

Let κ denote the circumscribed circle of the Delone triangle $P_1P_2P_3$. Since the radius of κ is smaller than r_0 , therefore P_3 is contained in the interior of the circumscribed circle of P_1P_2Q . Clearly, $\angle P_1P_2P_3 < \angle P_1P_2Q$ and thus, by Remark 1(i), $P_1P_3 < P_1Q = \nu_1$. Consider the intersection point Q^* different from P_1 of the segment P_1Q and κ . If we move a point F from P_3 to Q^* on the arc $\widehat{P_3Q^*}$ of κ not containing P_1 , then, by Remark 1(viii), the angle $\angle P_1FP_2$ decreases. Next, if we move the point F from Q^* to Q on the segment Q^*Q , then, by Remark 1(v), the angle $\angle P_1FP_2$ decreases again. This implies that $\angle P_1P_3P_2 > \angle P_1Q^*P_2 > \angle P_1QP_2$. In the triangle MP_2O

$$\cos \beta = \frac{\tan 30^\circ}{\tan r_0} = \frac{\tan \frac{b_0}{2}}{\tan 60^\circ}.$$

On the other hand, in the triangle $T^{(1)}$

$$\cos \beta_2 = \frac{\tan \frac{b_0}{2}}{\tan 60^\circ}.$$

Hence $\beta = \beta_2$. This yields that $\angle P_1P_2Q = 2\beta_2$ and the triangle P_2NQ is congruent to the half of the triangle $T^{(1)}$, consequently $\angle P_1QP_2 = \beta_1/2$. Thus $\angle P_1P_2P_3 < \angle P_1P_2Q = 2\beta_2$ and $\angle P_1P_3P_2 > \angle P_1QP_2 = \beta_1/2$.

The last assertion of the proposition is obvious. \square

Let ABC be a spherical triangle in which $AB = a$, $BC = b_0$ and whose circumscribed circle is of radius r_0 . Furthermore, let C^* be the midpoint of the arc \widehat{AB} of the circumscribed circle of ABC containing C . Set $\mu_1 = \angle CAB = 68.74185499\dots^\circ$, $\mu_2 = \angle C^*AB = 92.17540172\dots^\circ$, $\mu_3 = \angle CBA = 111.05500884\dots^\circ$, $\mu_4 = \angle ACB = 55.58894852\dots^\circ$, $\nu_2 = \angle AC^* = 93.76158737\dots^\circ$ and $\nu_3 = \angle AC = 101.58201699\dots^\circ$.

PROPOSITION 2. *Let, say, $P_1P_2P_3$ be a Delone triangle of type 2 of \mathcal{D} in which $P_1P_2 = a$ and $P_1P_3 \geq P_2P_3$, i.e., $\angle P_1P_2P_3 \geq \angle P_2P_1P_3$. Then*

- (i) $\mu_1 < \angle P_2P_1P_3 < \mu_2$,
- (ii) $\beta_5 \leq \angle P_1P_2P_3 < \mu_3$,
- (iii) $\mu_4 < \angle P_1P_3P_2 \leq \beta_4$,
- (iv) $P_2P_3 < \nu_2$,
- (v) $P_1P_3 < \nu_3$,
- (vi) $P_1P_2P_3$ contains the centre of its circumscribed circle.

PROOF. Consider the triangle P_1P_2Q in which $P_2Q = b_0$, the points P_3 and Q are not separated by the line P_1P_2 , and whose circumscribed circle is of radius r_0 . Furthermore, let O denote the centre of the circumscribed circle of P_1P_2Q and let Q^* be the midpoint of the arc $\widehat{P_1P_2}$ of the circumscribed circle containing Q (see Fig. 4).

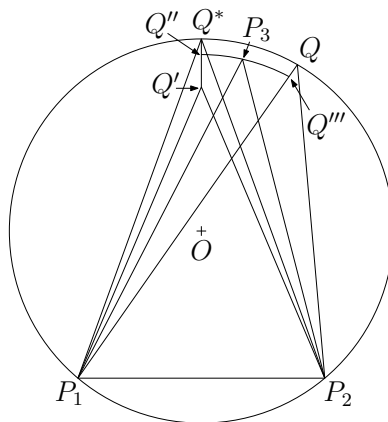

Fig. 4

Let κ denote the circumscribed circle of the Delone triangle $P_1P_2P_3$. Since the radius of κ is smaller than r_0 , therefore P_3 is contained in the interior of the circumscribed circle of P_1P_2Q . Clearly, $P_2P_3 < P_2Q^* = \nu_2$ and $P_1P_3 < P_1Q = \nu_3$, furthermore $\mu_1 = \angle QP_1P_2 < \angle P_3P_1P_2 < \angle Q^*P_1P_2 = \mu_2$ and $\beta_5 = \angle Q'P_2P_1 \leq \angle P_3P_2P_1 < \angle QP_2P_1 = \mu_3$ where Q' denotes the point on the segment OQ^* for which $P_1Q' = P_2Q' = b_0$.

Consider the intersection point Q''' different from P_1 of the segment P_1Q and κ . If we move a point F from P_3 to Q''' on the arc $\widehat{P_3Q'''} of κ not containing P_1 , then, by Remark 1(viii), the angle $\angle P_1FP_2$ decreases. Next, if we move the point F from Q''' to Q on the segment $Q'''Q$, then, by Remark 1(v), the angle $\angle P_1FP_2$ decreases again. This implies that $\angle P_1P_3P_2 > \angle P_1Q'''P_2 > \angle P_1QP_2 = \mu_4$.$

To prove that $\angle P_1P_3P_2 \leq \beta_4$ consider the intersection point Q'' of the segment OQ^* and κ . Clearly, $P_1Q'' = P_2Q'' \geq P_2P_3 \geq b_0$. If we move a point F from P_3 to Q'' on the arc $\widehat{P_3Q''}$ of κ not containing P_1 , then, by Remark 1(viii), the angle $\angle P_1FP_2$ increases, hence $\angle P_1P_3P_2 \leq \angle P_1Q''P_2$. Since the segment $Q'Q^*$ contains Q'' , therefore, by Remark 1(vi), $\angle P_1Q''P_2 \leq \max(\angle P_1Q^*P_2, \angle P_1Q'P_2)$. We know that $\angle P_1Q'P_2 = \beta_4$ and straightforward calculation shows that $\angle P_1Q^*P_2 = 60.14288812\dots^\circ < \beta_4$, from which $\angle P_1Q''P_2 \leq \beta_4$ follows. Thus $\angle P_1P_3P_2 \leq \angle P_1Q''P_2 \leq \beta_4$.

The last assertion of the proposition is obvious. \square

Let ABC be a spherical triangle in which $AB = BC = b_0$ and whose circumscribed circle is of radius r_0 . Set $\nu_4 = AC = 95.08531036\dots^\circ$, $\mu_5 = \angle ACB = 76.61459054\dots^\circ$ and $\mu_6 = \angle ABC = 97.90210237\dots^\circ$.

PROPOSITION 3. *Let, say, $P_1P_2P_3$ be a Delone triangle of type 3 of \mathcal{D} in which $P_1P_2 \leq P_2P_3 \leq P_3P_1$, i.e., $\angle P_1P_3P_2 \leq \angle P_2P_1P_3 \leq \angle P_3P_2P_1$. Then*

- (i) $\angle P_1P_3P_2 > \mu_5$,
- (ii) $\angle P_3P_2P_1 < \mu_6$,
- (iii) $P_3P_1 < \nu_4$,
- (iv) $P_1P_2P_3$ contains the centre of its circumscribed circle.

PROOF. Consider the triangle MP_2Q in which $MP_2 = P_2Q = b_0$, the points P_3 and Q are not separated by the line P_1P_2 , whose circumscribed circle, denote it by κ , is of radius r_0 , the point P_1 lies on κ and the smaller arc $\widehat{P_1P_2}$ of κ contains M . Let O denote the centre of κ (see Fig. 5).

Since the radius of the circumscribed circle of the Delone triangle $P_1P_2P_3$ is smaller than r_0 , therefore P_3 is contained in the interior of κ . Combining with the fact that O is contained in the interior of the triangle MP_2Q this implies that $\angle P_1P_2P_3 < \angle MP_2Q = \mu_6$ and $P_1P_3 < MQ = \nu_4$.

To prove that $\angle P_1P_3P_2 > \mu_5$ consider the midpoint Q^* of the arc $\widehat{MP_2}$ of κ containing Q . Since $P_1P_3 \geq P_2P_3$ and $MP_3 \geq P_1P_3$, therefore P_3 and Q

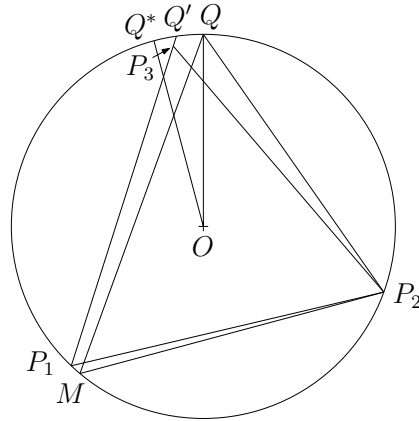

Fig. 5

are not separated by the line OQ^* and thus P_3 is contained in the convex circle sector in κ bounded by the segments OQ^* and OQ . The farthest point of this circle sector from P_2 is Q^* , hence the distance of any point of this circle sector from P_2 is at most $P_2Q^* = 87.55109029\dots^\circ < 90^\circ$. Let Q' be the intersection point different from P_1 of the line P_1P_3 and κ . If we move a point F from P_3 to Q' on the segment P_3Q' , then, by Remark 1(v), the angle $\angle P_1FP_2$ decreases. Hence $\angle P_1P_3P_2 > \angle P_1Q'P_2$. Next, if we move the point F from Q' to Q on the arc $Q'Q$ of κ not containing M , then, by Remark 1(viii), the angle $\angle MFP_2$ also decreases. Thus $\angle MQ'P_2 > \angle MQP_2$. Taking into account that $\angle P_1Q'P_2 \geq \angle MQ'P_2$ the inequality $\angle P_1P_3P_2 > \angle MQP_2 = \mu_5$ follows.

The last assertion of the proposition is obvious. \square

The next result is due to László Fejes Tóth [3].

PROPOSITION 4. *Let $s \leq 90^\circ$. If the length of each side of a spherical triangle is at least s and the radius of the circumscribed circle of this triangle is at most s , then the area of this triangle is greater than or equal to the area of a regular spherical triangle of side length s with equality if and only if the two triangles are congruent.*

PROPOSITION 5. *Any Delone triangle of type 3 in \mathcal{D} is of area at least t_3 .*

PROOF. It is an immediate consequence of Proposition 4. \square

PROPOSITION 6. *Any Delone triangle of type 1 in \mathcal{D} is of area at least t_1 .*

PROOF. Let, say, $P_1P_2P_3$ be a Delone triangle of type 1 in which $P_1P_2 = P_2P_3 = a$. Consider the triangle P_1P_2Q in which $P_1Q = b_0$, $P_2Q = a$ and

whose vertex Q is not separated from P_3 by the line P_1P_2 . Also, consider the triangle P_1P_2Q' in which $P_1Q' = \nu_1$, $P_2Q' = a$ and whose vertex Q' is not separated from P_3 by the line P_1P_2 (see Fig. 6).

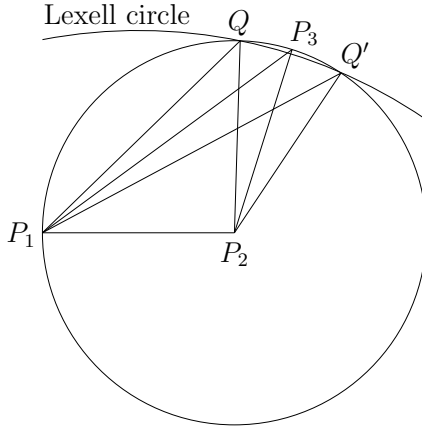

Fig. 6

Now $P_1Q \leq P_1P_3 < P_1Q'$, by Proposition 1, and $|P_1P_2Q| = |P_1P_2Q'|$ as we have observed at the end of the proof of Proposition 1. Consider the circle κ with centre P_2 and of radius a and the Lexell circle of the triangle P_1P_2Q with respect to its side P_1P_2 . This Lexell circle contains the point Q' , by Remark 1(vii), and separates the point P_3 from the segment P_1P_2 in κ since P_3 lies on the arc $\widehat{QQ'}$ of κ not containing P_1 . Let Q'' be the intersection point of the segment P_1P_3 and the Lexell circle. Then, by Remark 1(vii), $|P_1P_2P_3| \geq |P_1P_2Q''| = |P_1P_2Q| = t_3$. \square

PROPOSITION 7. Any Delone triangle of type 2 in \mathcal{D} is of area at least t_2 .

PROOF. Let, say, $P_1P_2P_3$ be a Delone triangle of type 2 in which $P_1P_2 = a$. Consider the triangle P_1P_2Q in which $P_1Q = P_2Q = b_0$ and whose vertex Q is not separated from P_3 by the line P_1P_2 , the triangle P_1P_2Q' in which $P_1Q' = b_0$, $P_2Q' = \nu_3$ and whose vertex Q' is not separated from P_3 by the line P_1P_2 and the triangle P_1P_2Q'' in which $P_1Q'' = \nu_3$, $P_2Q'' = b_0$ and whose vertex Q'' is not separated from P_3 by the line P_1P_2 . Let κ denote the common circumscribed circle of P_1P_2Q' and P_1P_2Q'' . Note that the radius of κ is r_0 . Furthermore, let κ' and κ'' denote the circles of radius b_0 with centres P_1 and P_2 , respectively. Finally, let \mathcal{Z} denote the region in κ bounded by the smaller arc $\widehat{Q'Q}$ of κ' , the smaller arc $\widehat{Q''Q}$ of κ'' and the smaller arc $\widehat{Q'Q''}$ of κ (see Fig. 7).

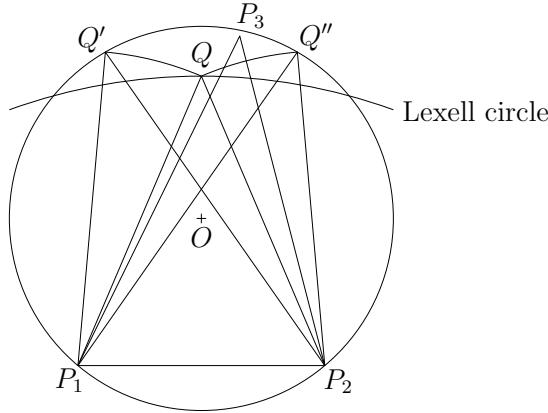

Fig. 7

Clearly, P_3 is contained in \mathcal{Z} . Observe that, if we move a point F from Q to Q' or Q'' on the arc $\widehat{QQ'}$ or on the arc $\widehat{QQ''}$ of the boundary of the region \mathcal{Z} , respectively, then, by Remark 1(ix), the area of the triangle P_1P_2F increases (it is easy to see that P_1P_2F contains the centre of its circumscribed circle). This implies that the Lexell circle of the triangle P_1P_2Q with respect to its side P_1P_2 separates the region \mathcal{Z} and the segment P_1P_2 in κ , from which $|P_1P_2P_3| \geq |P_1P_2Q| = t_2$ follows. \square

5. Proof of Theorem 4

Let \mathcal{P} be a set of 12 points P_1, P_2, \dots, P_{12} on \mathbb{S}^2 such that

- the distance between any two different points of \mathcal{P} is either a or at least b_0 ,
- the radius of any circle whose interior does not contain any point of \mathcal{P} is smaller than r_0 .

Let \mathcal{D} be a Delone triangulation of \mathcal{P} . By Euler's formula, \mathcal{D} consists of 12 vertices, 30 edges and 20 triangle faces. The edges and the triangle faces of \mathcal{D} will be consistently referred to as Delone edges and Delone triangles, respectively. Let L_1, L_2, \dots, L_{20} denote the Delone triangles of \mathcal{D} . Let k denote the number of Delone edges of length a , and let n denote the number of Delone edges of length at least b_0 of \mathcal{D} . Note that $k + n = 30$.

Consider the subgraph of \mathcal{D} formed by the Delone edges (and their endpoints) of length a . We call this graph the a -graph of \mathcal{P} and denote it by \mathcal{A} .

The following remark collects some basic facts about \mathcal{A} .

REMARK 2. (i) The angle between any two angularly consecutive edges adjacent to a vertex of \mathcal{A} is either α_3 or greater than or equal to β_1 . This follows from Propositions 1 and 2, taking into account that $\beta_1 < 2\mu_1$.

(ii) Each vertex of \mathcal{A} is of degree at most 4 since $5\alpha_3 = 352.64389682\dots^\circ < 360^\circ$, $4\alpha_3 + \beta_1 > 360^\circ$ and $6\alpha_3 > 360^\circ$.

(iii) If a vertex P_i of \mathcal{A} is of degree 4 and it is a common vertex of three Delone triangles of type 0, then in the fourth wedge, denote it by \mathcal{W} , with apex P_i and of angle $\mu_7 = 360^\circ - 3\alpha_3 = 148.41366619\dots^\circ$ there is at least one Delone edge of length at least b_0 adjacent to P_i , since $\mu_7 > 2\beta_2 = 124.20791532\dots^\circ$. In fact, there is exactly one Delone edge of length at least b_0 adjacent to P_i in \mathcal{W} . Indeed, suppose, for contradiction, that there are at least two Delone edges of length at least b_0 adjacent to P_i in \mathcal{W} . Since the angle of a Delone triangle between a side of length a and a side of length at least b_0 is greater than $\beta_1/2$, by Propositions 1 and 2, and the angle of a Delone triangle between two sides of length at least b_0 is greater than μ_4 , by Propositions 2 and 3, we obtain that the angle of \mathcal{W} is greater than $\beta_1 + \mu_4 = 148.85913605\dots^\circ > \mu_7$, a contradiction.

(iv) If a vertex P_i of \mathcal{A} is of degree 4 and it is a common vertex of two Delone triangles of type 0, then either the other two wedges with apex P_i are of equal angle $\alpha_4 = 109.47122063\dots^\circ$ or the thinner one of the other two wedges is of angle greater than or equal to β_1 and is smaller than α_4 and the fatter one is of angle greater than α_4 and is smaller than or equal to $\mu_8 = 2\alpha_4 - \beta_1 = 125.67225373\dots^\circ$. In the latter case there is no Delone edge of length at least b_0 adjacent to P_i in the thinner wedge and there is at most one Delone edge of length at least b_0 adjacent to P_i in the fatter wedge. The second part of this assertion follows from the fact that if there were at least two Delone edges of length at least b_0 adjacent to P_i in the fatter wedge then the angle of this wedge would be greater than $\beta_1 + \mu_4 > \mu_8$, as we have seen in (iii). The first part of the assertion follows from the fact that if P_h, P_i and P_j are three vertices of \mathcal{D} such that $P_iP_h = P_iP_j = a$ and $\angle P_hP_iP_j < \alpha_4$, then it is easy to see that the union of the interiors of the three circles of radius a with centres P_h, P_i and P_j covers the circumscribed circle of $P_hP_iP_j$, hence $P_hP_iP_j$ is a Delone triangle of \mathcal{D} .

(v) If a vertex P_i of \mathcal{A} is of degree 4, then it is adjacent to at least one Delone triangle of type 0 since $4\beta_1 > 360^\circ$. If P_i is adjacent to exactly one Delone triangle of type 0, then the other three wedges with apex P_i are of angle at most $360^\circ - \alpha_3 - 2\beta_1 = 102.93084556\dots^\circ < \alpha_4$, hence, as we have seen in (iv), there is no Delone edge of length at least b_0 adjacent to P_i in these wedges. Therefore in this case P_i is a common vertex of one Delone triangle of type 0 and three Delone triangles of type 1.

(vi) The smaller angle of a rhombus face of \mathcal{A} is greater than or equal to β_1 and is smaller than or equal to α_4 and the greater angle of this rhombus is greater than or equal to α_4 and is smaller than or equal to $2\beta_2$, by Proposition 1.

(vii) Let P_i be a vertex of \mathcal{A} and consider a wedge \mathcal{W} with apex P_i bounded by two angularly consecutive edges of \mathcal{A} . If the angle of \mathcal{W} is greater than β_1

and is smaller than α_4 , then there is no Delone edge of length at least b_0 adjacent to P_i in \mathcal{W} . If the angle of \mathcal{W} is greater than or equal to α_4 and is smaller than or equal to $2\beta_2$, then there is at most one Delone edge of length at least b_0 adjacent to P_i in \mathcal{W} . If the angle of \mathcal{W} is greater than $2\beta_2$, then, by (vi), the two angularly consecutive edges cannot bound a rhombus face of \mathcal{A} .

(viii) Since each vertex of \mathcal{A} is of degree at most 4, therefore $k \leq 24$.

LEMMA 1. *If a vertex, say, P_1 of \mathcal{D} is a common vertex of three Delone triangles, say, $P_1P_2P_3$, $P_1P_3P_4$, $P_1P_4P_5$ of type 0 and a Delone edge, say, P_1P_6 of length at least b_0 of \mathcal{D} , then none of the vertices P_2 , P_5 and P_6 is a common vertex of three Delone triangles of type 0 of \mathcal{D} .*

PROOF. First, suppose, for contradiction, that P_6 is a common vertex of three Delone triangles of type 0. Since P_6P_1 is a Delone edge of length at least b_0 , therefore $P_6P_2 = P_6P_5 = a$ and thus $P_1P_5P_6P_2$ is a rhombus face of \mathcal{A} in which $\angle P_2P_1P_5 = \mu_7 > 2\beta_2$, contradicting to Remark 2(vi).

Next, suppose, for contradiction, that P_5 is a common vertex of three Delone triangles of type 0. One of these triangles is $P_5P_1P_4$, and let, say, $P_5P_4P_7$ and $P_5P_7P_8$ be the other two of these triangles (see Fig. 8).

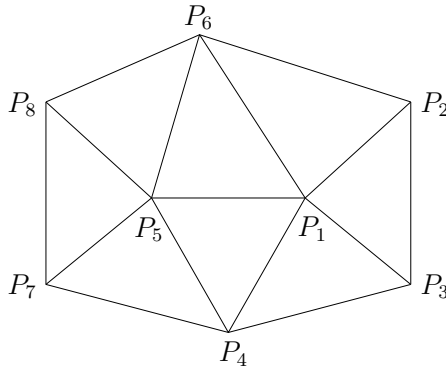

Fig. 8

Then, by Remark 2(iii), P_5P_6 is a Delone edge of length at least b_0 . Now $\angle P_8P_5P_1 = \angle P_5P_1P_2 = \mu_7$. By symmetry, we may assume, without loss of generality, that $P_1P_6 \geq P_5P_6$, and thus $\angle P_6P_5P_1 \geq \angle P_6P_1P_5$. Then, by Proposition 2, $\angle P_6P_5P_1 \geq \beta_5$, consequently $\angle P_6P_5P_8 \leq \mu_7 - \beta_5 = 65.43799512\dots^\circ$. If P_6P_8 is a Delone edge of length at least b_0 , then, by Proposition 2, $\angle P_6P_5P_8 > \mu_1 = 68.74185499\dots^\circ$, a contradiction. Hence $P_6P_8 = a$.

Straightforward calculation shows that $P_2P_8 = 125.46791109\dots^\circ$ and $\angle P_5P_8P_2 = 98.04946697\dots^\circ$ in the quadrangle $P_2P_1P_5P_8$. Since $P_8P_6 = a$, therefore $P_6P_2 \geq b_0$ in the triangle $P_8P_6P_2$.

Consider the point Q for which $P_8Q = a$, $QP_2 = b_0$ and which is not separated from P_6 by the line P_8P_2 . Straightforward calculation shows that $\angle QP_8P_2 = 45.1607165376\dots^\circ$. Since $QP_2 \leq P_6P_2$, hence, by Remark 1(i), $\angle QP_8P_2 \leq \angle P_6P_8P_2$.

Now, if P_6 and Q are separated from the quadrangle $P_2P_1P_5P_8$ by the line P_8P_2 , then

$$\angle P_5P_8P_6 \geq \angle P_5P_8Q = \angle P_5P_8P_2 + \angle P_2P_8Q = 143.21018351\dots^\circ > 2\beta_2,$$

contradicting to Proposition 1.

On the other hand, if P_6 and Q are not separated from the quadrangle $P_2P_1P_5P_8$ by the line P_8P_2 , then

$$\angle P_5P_8P_6 \leq \angle P_5P_8Q = \angle P_5P_8P_2 - \angle P_2P_8Q = 52.88875043\dots^\circ < \beta_1,$$

contradicting to Proposition 1 again.

Similar argument shows that P_2 is not a common vertex of three Delone triangles of type 0 either. \square

For $0 \leq i \leq 3$, let n_i denote the number of Delone triangles of type i in \mathcal{D} . Now

$$\sum_{i=0}^3 n_i = 20,$$

and

$$2k = 3n_0 + 2n_1 + n_2, \quad 2n = n_1 + 2n_2 + 3n_3.$$

Hence $n_0 + n_2 = 2k - 2n_0 - 2n_1$ is an even number and $n_1 + n_3 = 2n - 2n_2 - 2n_3$ is also an even number.

LEMMA 2. *If there is a vertex, say, P_1 of \mathcal{D} which is a common vertex of three Delone triangles of type 0 of \mathcal{D} , then $n_0 \leq 10$.*

PROOF. Let, say, $P_1P_2P_3$, $P_1P_3P_4$ and $P_1P_4P_5$ be the Delone triangles of type 0 whose common vertex is P_1 . Now, by Remark 2(iii), there is one Delone edge, say P_1P_6 , of length at least b_0 adjacent to P_1 in the wedge with apex P_1 bounded by P_1P_2 and P_1P_5 . By Lemma 1, each of P_5 , P_6 and P_2 is a common vertex of at most two Delone triangles of type 0. We claim that there is at least one other vertex in \mathcal{D} different from P_5 , P_6 and P_2 which is a common vertex of at most two Delone triangles of type 0, too. If P_4 is a common vertex of at most two Delone triangles of type 0, then we are done. On the other hand, if P_4 is a common vertex of three Delone triangles of

type 0, then, by Remark 2(iii), there is one Delone edge, say P_4P_7 , of length at least b_0 adjacent to P_4 , and P_7 is a common vertex of at most two Delone triangles of type 0, by Lemma 1.

Next, let I denote the number of incidences between the vertices and the Delone triangles of type 0 of \mathcal{D} . On one hand, obviously, $I = 3n_0$. On the other hand, $I \leq 12 \cdot 3 - 4 = 32$, since each vertex of \mathcal{D} is a common vertex of at most three Delone triangles of type 0, by Remark 2(ii) and (iii), and, as we have seen above, there are at least four vertices each of which is a common vertex of at most two Delone triangles of type 0. This implies that $3n_0 \leq 32$, from which $n_0 \leq 10$ follows. \square

LEMMA 3. *No vertex of \mathcal{D} is a common vertex of three Delone triangles of type 0 of \mathcal{D} .*

PROOF. Suppose, for contradiction, that there is a vertex of \mathcal{D} which is a common vertex of three Delone triangles of type 0 of \mathcal{D} . Let l_3 denote the number of such vertices in \mathcal{D} . Let, say, P_1 be a common vertex of three Delone triangles, say, $P_1P_2P_3$, $P_1P_3P_4$, $P_1P_4P_5$ of type 0 of \mathcal{D} . Then, by Remark 2(iii), there is exactly one Delone edge, say, P_1P_6 of length at least b_0 adjacent to P_1 in the wedge with apex P_1 bounded by P_1P_2 and P_1P_5 . Since $\angle P_2P_1P_5 = \mu_7 > 2\beta_2$, therefore, by Remark 2(vii), $P_2P_1P_5P_6$ is not a rhombus, hence P_2P_6 or P_5P_6 is of length at least b_0 . This implies that $P_1P_2P_6$ or $P_1P_5P_6$ is a Delone triangle of type 2. By Lemma 1, none of the vertices P_2 , P_5 and P_6 is a common vertex of three Delone triangles of type 0 of \mathcal{D} . This yields, among other things, that $l_3 \leq n_2$.

We will distinguish three cases.

(1) Suppose that $l_3 \geq 3$. Then $n_2 \geq 3$ and $n_0 \leq 10$, by Lemma 2, furthermore, we know that $n_0 + n_2$ is an even number. Now, on one hand,

$$\sum_{j=1}^{20} |L_j| = 720^\circ.$$

On the other hand, by Propositions 5, 6 and 7,

$$\sum_{j=1}^{20} |L_j| \geq n_0t_0 + n_1t_1 + n_2t_2 + n_3t_3.$$

Since $n_0 + n_1 + n_2 + n_3 = 20$, therefore

$$\begin{aligned} n_0t_0 + n_1t_1 + n_2t_2 + n_3t_3 &= n_0t_0 + (20 - n_0 - n_2 - n_3)t_1 + n_2t_2 + n_3t_3 \\ &= 20t_1 - n_0(t_1 - t_0) + n_2(t_2 - t_1) + n_3(t_3 - t_1). \end{aligned}$$

Taking into account that $t_1 - t_0 < t_2 - t_1 < t_3 - t_1$ we obtain that

$$20t_1 - n_0(t_1 - t_0) + n_2(t_2 - t_1) + n_3(t_3 - t_1)$$

is minimal when $n_0 = 9$, $n_2 = 3$ and $n_3 = 0$. Hence

$$\sum_{j=1}^{20} |L_j| \geq 9t_0 + 8t_1 + 3t_2 = 726.37592720 \dots^\circ > 720^\circ,$$

a contradiction.

(2) Suppose that $l_3 = 2$. Let I denote the number of incidences between the vertices and the Delone triangles of type 0 of \mathcal{D} . On one hand, obviously, $I = 3n_0$. On the other hand, $I \leq 2 \cdot 3 + 10 \cdot 2 = 26$. This implies that $3n_0 \leq 26$, from which $n_0 \leq 8$ follows. We also know that $n_2 \geq 2$. Now, an argument similar to that which has been used in (1) yields that

$$\sum_{j=1}^{20} |L_j| \geq 8t_0 + 10t_1 + 2t_2 = 722.32110766 \dots^\circ > 720^\circ,$$

a contradiction.

(3) Suppose that $l_3 = 1$. Again, let I denote the number of incidences between the vertices and the Delone triangles of type 0 of \mathcal{D} . On one hand, obviously, $I = 3n_0$. On the other hand, $I \leq 1 \cdot 3 + 11 \cdot 2 = 25$. This implies that $3n_0 \leq 25$, from which $n_0 \leq 8$ follows. If $n_2 \geq 2$, then, as we have already seen in (2),

$$\sum_{j=1}^{20} |L_j| \geq 8t_0 + 10t_1 + 2t_2 = 722.32110766 \dots^\circ > 720^\circ,$$

a contradiction. Therefore $n_2 = 1$ in this case. Note that, this implies, among other things, that $n_0 \leq 7$, since $n_0 + n_2$ is an even number.

Now, we may assume, without loss of generality, that the Delone triangle $P_1P_2P_6$ is of type 1 and the Delone triangle $P_1P_5P_6$ is of type 2, i.e., $P_2P_6 = a$ and $P_5P_6 \geq b_0$. Let, say, $P_7P_5P_6$ be the other Delone triangle adjacent to the Delone edge P_5P_6 . We know that $P_7P_5P_6$ cannot be a Delone triangle of type 2. If $P_7P_5P_6$ is a Delone triangle of type 3, then $n_3 \geq 1$, and thus, an argument similar to that which has been used in (1) yields that

$$\sum_{j=1}^{20} |L_j| \geq 7t_0 + 11t_1 + t_2 + t_3 = 741.13719285 \dots^\circ > 720^\circ,$$

a contradiction. Therefore, $P_7P_5P_6$ is a Delone triangle of type 1. Note that $n_3 = 0$ also holds in this case.

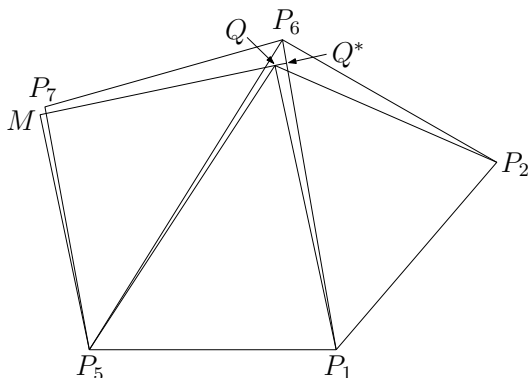

Fig. 9

Consider the point Q for which $P_2Q = a$, $P_1Q = b_0$ and which is not separated from P_6 by the line P_1P_2 . Straightforward calculation shows that $b_1 = P_5Q = 80.90112390\dots^\circ$ and $t'_2 = |P_1P_5Q| = 48.76479112\dots^\circ$. Furthermore, consider the point M for which $QM = P_5M = a$ and which is separated from P_1 by the line P_5Q (see Fig. 9).

Again, straightforward calculation shows that

$$\mu_9 = \angle MP_5Q = \angle MQP_5 = 60.51189978\dots^\circ,$$

$$\angle QMP_5 = 97.03535233\dots^\circ \quad \text{and} \quad t'_1 = |QP_5M| = 38.05915190\dots^\circ.$$

By Proposition 1, $\angle P_2P_1P_6 \leq \angle P_2P_1Q = \beta_2$, hence $\angle P_6P_1P_5 \geq \angle QP_1P_5$. Let Q^* be the point on the Delone edge P_1P_6 for which $P_1Q^* = b_0$. If we move a point F from Q to Q^* on the arc $\widehat{QQ^*}$ of the circle with centre P_1 and of radius b_0 , then, by Remark 1(ix), the area of the triangle P_1P_5F increases, and, by Remark 1(i), the length of the side P_5F also increases. Next, if we move the point F from Q^* to P_6 on the segment Q^*P_6 , then, clearly, the area of the triangle P_1P_5F increases, and, by Remark 1(iv), the length of the side P_5F also increases. This implies that $|P_1P_5P_6| \geq |P_1P_5Q^*| \geq |P_1P_5Q| = t'_2$ and $P_5P_6 \geq P_5Q^* \geq P_5Q$. Furthermore, since $P_5P_6 \geq P_5Q$, therefore, by Remark 1(i), $\angle P_5P_7P_6 \geq \angle P_5MQ$ and thus, by Remark 1(ix), $|P_5P_6P_7| \geq |P_5QM| = t'_1$.

Consequently,

$$\begin{aligned} \sum_{j=1}^{20} |L_j| &\geq n_0t_0 + (18 - n_0)t_1 + t'_1 + t'_2 \\ &\geq 7t_0 + 11t_1 + t'_1 + t'_2 = 720.18744114\dots^\circ > 720^\circ, \end{aligned}$$

a contradiction. \square

REMARK 3. (i) Let I denote the number of incidences between the vertices and the Delone triangles of type 0 of \mathcal{D} . On one hand, obviously, $I = 3n_0$. On the other hand, $I \leq 12 \cdot 2 = 24$, since, by Lemma 3, no vertex of \mathcal{D} is a common vertex of three Delone triangles of type 0 of \mathcal{D} . This implies that $3n_0 \leq 24$, from which $n_0 \leq 8$ follows.

(ii) If $n_3 \geq 1$, then an argument similar to that which has been used in case (1) in the proof of Lemma 3 yields that

$$\sum_{j=1}^{20} |L_j| \geq 8t_0 + 11t_1 + t_3 = 725.29884379 \dots^\circ > 720^\circ,$$

a contradiction. This implies that $n_3 = 0$, i.e., there exists no Delone triangle of type 3 in \mathcal{D} .

(iii) If $n_2 \geq 2$, then again an argument similar to that which has been used in case (1) in the proof of Lemma 3 yields that

$$\sum_{j=1}^{20} |L_j| \geq 8t_0 + 10t_1 + 2t_2 = 722.32110766 \dots^\circ > 720^\circ,$$

a contradiction. This implies that $n_2 \leq 1$, i.e., there exists at most one Delone triangle of type 2 in \mathcal{D} . Note that, if $n_2 = 1$, then $n_0 \leq 7$, since $n_0 + n_2$ is an even number.

(iv) Since $n_3 = 0$ and $n_2 \leq 1$, therefore each vertex of \mathcal{D} is a vertex of \mathcal{A} as well, i.e., the number of vertices of \mathcal{A} is 12.

LEMMA 4. *The number of edges of \mathcal{A} is 24.*

PROOF. Recall that we denoted the number of edges in \mathcal{A} by k . We have already observed in Remark 2(viii) that $k \leq 24$.

First we show that $k > 22$. Suppose, for contradiction, that $k \leq 22$. Then $3n_0 + 2n_1 + n_2 \leq 44$. We know that $n_3 = 0$ and $n_2 \leq 1$. Since $n_0 + n_1 + n_2 = 20$, therefore $n_0 - n_2 \leq 4$.

If $n_2 = 0$, then $n_0 \leq 4$, and thus

$$\sum_{j=1}^{20} |L_j| \geq n_0 t_0 + (20 - n_0) t_1 \geq 4t_0 + 16t_1 = 725.99499811 \dots^\circ > 720^\circ,$$

a contradiction.

If $n_2 = 1$, then $n_0 \leq 5$, and thus

$$\sum_{j=1}^{20} |L_j| \geq n_0 t_0 + (19 - n_0) t_1 + t_2 \geq 5t_0 + 14t_1 + t_2 = 730.04981765 \dots^\circ > 720^\circ,$$

a contradiction again.

Next we show that $k \neq 23$. Suppose, for contradiction, that $k = 23$. Then $3n_0 + 2n_1 + n_2 = 46$. We know that $n_3 = 0$ and $n_2 \leq 1$. Since $n_0 + n_1 + n_2 = 20$, therefore $n_0 - n_2 = 6$. We will distinguish two cases.

(1) Suppose that $n_2 = 0$. Then $n_0 = 6$ and $n_1 = 14$. This means that \mathcal{A} has 6 regular triangle faces and 7 rhombus faces. Since the faces are convex polygons, therefore each vertex of \mathcal{A} is of degree at least three. Hence \mathcal{A} has 10 vertices of degree four and 2 vertices of degree three.

Let, say, P_1 be a vertex of degree three of \mathcal{A} . By Proposition 1, each of the three wedges with apex P_1 bounded by the edges of \mathcal{A} adjacent to P_1 is of angle at least $360^\circ - 4\beta_2 = 111.58416935\dots^\circ > \alpha_4$, therefore P_1 is a common vertex of three rhombus faces, say, $P_1P_2P_5P_3$, $P_1P_3P_6P_4$ and $P_1P_4P_7P_2$ of \mathcal{A} in which P_1P_5 , P_1P_6 and P_1P_7 are Delone edges of length at least b_0 of \mathcal{D} . Set $\mu_{10} = 360^\circ - 4\beta_2$ and let μ_{11} denote the smaller angle of the rhombus of side length a with greater angle μ_{10} . Straightforward calculation shows that $\mu_{11} = 107.33036193\dots^\circ$. Now, each of the three angles $\angle P_7P_2P_5$, $\angle P_5P_3P_6$ and $\angle P_6P_4P_7$ outside the union of the rhombi $P_1P_2P_5P_3$, $P_1P_3P_6P_4$ and $P_1P_4P_7P_2$ is greater than or equal to $360 - 2\mu_{11} = 145.33927612\dots^\circ$ and is smaller than or equal to $360 - 2\beta_1 = 173.45962492\dots^\circ$. This implies that each of the vertices P_2 , P_3 and P_4 of \mathcal{A} is a common vertex of three rhombus faces and one regular triangle face of \mathcal{A} , since the greater angle of a rhombus face of \mathcal{A} is at most $2\beta_2 < 145.33927612\dots^\circ$ and twice of the smaller angle of a rhombus face of \mathcal{A} is at least $2\beta_1 > 173.45962492\dots^\circ$ (cf. Remark 2(vi)).

Let I denote the number of incidences between the vertices and the Delone triangles of type 0 of \mathcal{D} . Since there are six Delone triangles of type 0 in \mathcal{D} , therefore $I = 18$. Let l_1 denote the number of vertices of \mathcal{D} which are incident to exactly one Delone triangle of type 0 of \mathcal{D} and let l_2 denote the number of vertices of \mathcal{D} which are incident to exactly two Delone triangles of type 0 of \mathcal{D} . We have seen above that the two vertices of degree three of \mathcal{A} are not incident to any Delone triangle of type 0. On the other hand, by Remark 2(v), each of the ten vertices of degree four of \mathcal{A} is incident to at least one Delone triangle of type 0. This implies that $l_1 + l_2 = 10$ and $l_1 + 2l_2 = 18$, from which $l_1 = 2$ and $l_2 = 8$ follows. But we also have seen above that each of the three vertices P_2 , P_3 and P_4 is incident to exactly one Delone triangle of type 0, a contradiction.

(2) Suppose that $n_2 = 1$. Then $n_0 = 7$ and $n_1 = 12$. This means that \mathcal{A} has 7 regular triangle faces, 5 rhombus faces and 1 pentagon face. Let, say, $P_1P_3P_4$ be the Delone triangle of type 2 of \mathcal{D} in which $P_3P_4 = a$ and $P_1P_3 \geq P_1P_4$. Furthermore, let, say, $P_1P_2P_3$ and $P_1P_4P_5$ be the Delone triangles of \mathcal{D} adjacent to the Delone triangle $P_1P_3P_4$ along the Delone edges P_1P_3 and P_1P_4 of length at least b_0 , respectively. Now $P_1P_2P_3$ and $P_1P_4P_5$ are Delone triangles of type 1 and the pentagon face, denote it by \mathcal{F} , of \mathcal{A} is composed of the Delone triangles $P_1P_2P_3$, $P_1P_3P_4$ and $P_1P_4P_5$.

If $P_1P_3 \geq b_1$, then an argument similar to that which has been used in case (3) in the proof of Lemma 3 yields that $|P_1P_3P_4| \geq t'_2$ and $|P_1P_4P_5| \geq t'_1$, thus

$$\sum_{j=1}^{20} |L_j| \geq 7t_0 + 11t_1 + t'_1 + t'_2 = 720.18744114\dots^\circ > 720^\circ,$$

a contradiction. Therefore $P_1P_3 < b_1$ and $P_1P_4 < b_1$.

By Propositions 1 and 2, $\angle P_2P_1P_3 \leq \beta_2$, $\angle P_3P_1P_4 \leq \beta_4$ and $\angle P_4P_1P_5 \leq \beta_2$, therefore the angle $\angle P_2P_1P_5$ inside \mathcal{F} is smaller than or equal to $2\beta_2 + \beta_4 = 185.68126893\dots^\circ$.

On the other hand, since $P_1P_3 < b_1$ and $P_1P_4 < b_1$, then, by Remark 1(i) and (ii), $\angle P_2P_1P_3 > \mu_9$ and $\angle P_4P_1P_5 > \mu_9$. To obtain a lower bound for $\angle P_3P_1P_4$ as well, consider the points Q' and Q'' for which $P_3Q' = P_3Q'' = P_4Q' = b_1$, $P_4Q'' = b_0$ and which are not separated from P_1 by the line P_3P_4 . Straightforward calculation shows that $\mu_{12} = \angle P_3Q'P_4 = 60.84490538\dots^\circ$ and $\mu_{13} = \angle P_3P_4Q'' = 86.30970424\dots^\circ$. Furthermore, consider the point Q of the line P_3P_1 for which $P_3Q = b_1$ and the segment P_3Q contains the point P_1 (see Fig. 10).

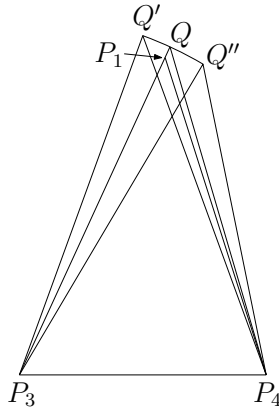

Fig. 10

By the triangle inequality, $QP_4 < QP_1 + P_1P_4 \leq QP_1 + P_1P_3 = b_1$, therefore, by Remark 1(iii), $\angle P_3P_1P_4 > \widehat{\angle P_3QP_4}$. Now, if we move a point F from Q to Q'' on the smaller arc $\widehat{QQ''}$ of the circle with centre P_3 and of radius b_1 , then, by Remark 1(ii), the angle $\angle P_3P_4F$ increases. Hence $\angle P_3P_4Q < \angle P_3P_4Q'' = \mu_{13} < 90^\circ$. Next, if we move a point F from Q to Q' on the smaller arc $\widehat{QQ'}$ of the circle with centre P_3 and of radius b_1 ,

then, again by Remark 1(ii), the angle $\angle P_3P_4F$ decreases and the angle $\angle P_3FP_4$ decreases, too. This implies that $\angle P_3QP_4 > \angle P_3Q'P_4$. Consequently, $\angle P_3P_1P_4 > \angle P_3QP_4 > \angle P_3Q'P_4 = \mu_{12}$ and thus the angle $\angle P_2P_1P_5$ inside \mathcal{F} is greater than $2\mu_9 + \mu_{12} = 181.86870495\dots^\circ$.

Therefore the angle $\angle P_2P_1P_5$ outside \mathcal{F} is greater than or equal to $360^\circ - 2\beta_2 - \beta_4 = 174.31873106\dots^\circ$ and is smaller than $360^\circ - 2\mu_9 - \mu_{12} = 178.13129504\dots^\circ$. This yields that P_1 is a common vertex of the pentagon face \mathcal{F} of \mathcal{A} , a rhombus face of \mathcal{A} and a regular triangle face of \mathcal{A} , since the greater angle of a rhombus face of \mathcal{A} is at most $2\beta_2 < 174.31873106\dots^\circ$, twice of the smaller angle of a rhombus face of \mathcal{A} is at least $2\beta_1 > 178.13129504\dots^\circ$ and the sum of the smaller angle of a rhombus face of \mathcal{A} and twice of the angle of a regular triangle face of \mathcal{A} is at least $\beta_1 + 2\alpha_3 > 178.13129504\dots^\circ$ (cf. Remark 2(vi)). Hence the angle at P_1 of the rhombus face of \mathcal{A} adjacent to P_1 is greater than or equal to $\mu_{14} = 360^\circ - 2\beta_2 - \beta_4 - \alpha_3 = 103.78995170\dots^\circ$ and is smaller than $360^\circ - 2\mu_9 - \mu_{12} - \alpha_3 = 107.60251567\dots^\circ$. Let t''_1 denote the area of a spherical triangle ABC in which $AB = BC = a$ and $\angle ABC = \mu_{14}$. Straightforward calculation shows that $t''_1 = 38.75016462\dots^\circ$. Then, by Remark 1(ix), the area of the rhombus face of \mathcal{A} adjacent to P_1 is greater than or equal to $2t''_1$, and thus

$$\sum_{j=1}^{20} |L_j| \geq 7t_0 + 10t_1 + 2t''_1 + t_2 = 720.81041167\dots^\circ > 720^\circ,$$

a contradiction. \square

LEMMA 5. (i) *Each vertex of \mathcal{A} is of degree 4.*

(ii) *The number of faces of \mathcal{A} is 14.*

(iii) *Eight faces of \mathcal{A} are regular triangles and six faces of \mathcal{A} are squares.*

(iv) *Each vertex of \mathcal{A} is adjacent to two regular triangle faces and two square faces of \mathcal{A} .*

PROOF. It follows from Remark 2(ii), Remark 3(iv) and Lemma 4 that each vertex of \mathcal{A} is of degree 4. Hence, by Remark 2(v) and Lemma 3, each vertex of \mathcal{A} is adjacent to one or two Delone triangles of type 0 of \mathcal{D} . If a vertex P_i of \mathcal{A} is adjacent to exactly one Delone triangle of type 0 of \mathcal{D} , then, by Remark 2(v), there is no Delone edge of length at least b_0 adjacent to P_i . If a vertex P_i of \mathcal{A} is adjacent to exactly two Delone triangles of type 0 of \mathcal{D} , then, by Remark 2(iv), there is at most one Delone edge of length at least b_0 adjacent to P_i in each of the other two wedges with apex P_i . This implies that $n_2 = 0$ in \mathcal{D} , therefore the faces of \mathcal{A} are regular triangles and rhombi. Since $n_0 + n_1 = 20$ and $3n_0 + 2n_1 = 48$, hence $n_0 = 8$ and $n_1 = 12$, i.e., there are 8 regular triangle faces and 6 rhombus faces in \mathcal{A} .

By Remark 1(ix), the area of a rhombus of side length a is smaller than or equal to the area of a square of side length a with equality if and only

if the rhombus is a square. Since the Archimedean tiling $(3, 4, 3, 4)$ of \mathbb{S}^2 consists of 8 regular triangle faces of side length a and 6 square faces of side length a , therefore the faces of \mathcal{A} can form a tiling of \mathbb{S}^2 only if each rhombus face of \mathcal{A} is a square. This implies that each rhombus face of \mathcal{A} is a square and each vertex of \mathcal{A} is adjacent to two regular triangle faces and two square faces of \mathcal{A} . \square

Now, the proof of Theorem 4 can be completed as follows. If each edge of \mathcal{A} is adjacent to one regular triangle face and one square face of \mathcal{A} , then \mathcal{A} is congruent to the Archimedean tiling $(3, 4, 3, 4)$ of \mathbb{S}^2 and thus \mathcal{P} is congruent to \mathcal{C} . If there is an edge of \mathcal{A} adjacent to either two regular triangle faces or two square faces of \mathcal{A} , then it is easy to see that the great circle incident to this edge consists of six such edges of \mathcal{A} , alternately adjacent to either two regular triangle faces or two square faces of \mathcal{A} . In this case \mathcal{P} is congruent to \mathcal{C}' .

6. Concluding remarks

We note that the proof of Corollary 3 yields a bit stronger result.

COROLLARY 4. *Suppose that a unit ball B_0 has twelve neighbors and each of these twelve neighbours also has twelve neighbours in a packing of unit balls in \mathbb{E}^3 . Then the Dirichlet–Voronoi cell of B_0 is either a rhombic dodecahedron or a trapezo-rhombic dodecahedron circumscribed about B_0 .*

We also mention an interesting open problem related to Theorem 4. Let ABC be an Euclidean triangle in which $AB = BC = 2$ and $AC = 4\sqrt{(58 - \sqrt{475})/107}$. Set $b' = \angle ABC = 71.13971322\dots^\circ$.

CONJECTURE 1. *Let \mathcal{P} be a set of 12 points on \mathbb{S}^2 such that the distance between any two different points of \mathcal{P} is at least 60° and suppose that \mathcal{P} is congruent to neither \mathcal{C} nor \mathcal{C}' . Then there exist two different points in \mathcal{P} whose distance is greater than 60° and is smaller than or equal to b' .*

Note that Conjecture 1 together with a much weaker version of Theorem 3 also implies Theorem 1.

7. Appendix

For the readers's convenience, we list here the constants used in the proof. Set

$$\begin{aligned} a_0 &= 57.13670309^\circ, & b_0 &= 78.04071344^\circ, \\ r_0 &= (180^\circ - b_0)/2 = 50.97964328^\circ. \end{aligned}$$

Set $a = 60^\circ$. In a regular triangle ABC of side length a set

$$\alpha_3 = \angle CAB = \angle ABC = \angle BCA = 70.52877936\dots^\circ,$$

$$t_0 = |ABC| = 31.58633809\dots^\circ.$$

In an isosceles triangle ABC with $AB = BC = a$ and $AC = b_0$ set

$$\beta_1 = \angle ABC = 93.27018753\dots^\circ,$$

$$\beta_2 = \angle CAB = \angle BCA = 62.10395766\dots^\circ,$$

$$t_1 = |ABC| = 37.47810285\dots^\circ.$$

In an isosceles triangle ABC with $AB = BC = b_0$ and $AC = a$ set

$$\beta_4 = \angle ABC = 61.47335360\dots^\circ,$$

$$\beta_5 = \angle CAB = \angle BCA = 82.97566677\dots^\circ,$$

$$t_2 = |ABC| = 47.42468715\dots^\circ.$$

In a regular triangle ABC of side length b_0 set

$$\beta_3 = \angle CAB = \angle ABC = \angle BCA = 80.11633586\dots^\circ,$$

$$t_3 = |ABC| = 60.34900758\dots^\circ.$$

In an isosceles triangle ABC with $AB = BC = a$ and circumradius r_0 set

$$\nu_1 = AC = 99.88366413\dots^\circ.$$

In a triangle ABC with $AB = a$, $BC = b_0$ and circumradius r_0 set

$$\mu_1 = \angle CAB = 68.74185499\dots^\circ, \quad \mu_3 = \angle CBA = 111.05500884\dots^\circ,$$

$$\mu_4 = \angle ACB = 55.58894852\dots^\circ, \quad \nu_3 = AC = 101.58201699\dots^\circ.$$

In an isosceles triangle ABC with $AB = a$, $\widehat{BC} = AC$ and circumradius r_0 , where C is the midpoint of the longer arc \widehat{AB} on the circumscribed circle of ABC set

$$\mu_2 = \angle CAB = \angle CBA = 92.17540172\dots^\circ,$$

$$\nu_2 = AC = BC = 93.76158737\dots^\circ.$$

In an isosceles triangle ABC with $AB = BC = b_0$ and circumradius r_0 set

$$\nu_4 = AC = 95.08531036\dots^\circ,$$

$$\mu_5 = \angle ACB = \angle CAB = 76.61459054\dots^\circ,$$

$$\mu_6 = \angle ABC = 97.90210237\dots^\circ.$$

Set

$$\mu_7 = 360^\circ - 3\alpha_3 = 148.41366619\dots^\circ$$

In a square $ABCD$ of side length a set

$$\alpha_4 = \angle ABC = \angle BCD = \angle CDA = \angle DAB = 109.47122063\dots^\circ.$$

Set

$$\mu_8 = 2\alpha_4 - \beta_1 = 125.67225373\dots^\circ$$

In a quadrangle $ABCD$ with $AB = BC = DA = a$, $CA = b_0$ and $\angle DAB = \mu_7$ set

$$b_1 = CD = 80.90112390\dots^\circ,$$

$$t'_2 = |\angle ACD| = 48.76479112\dots^\circ.$$

In an isosceles triangle ABC with $AB = b_1$ and $AC = BC = a$ set

$$\mu_9 = \angle CAB = \angle CBA = 60.51189978\dots^\circ,$$

$$t'_1 = |\angle ABC| = 38.05915190\dots^\circ.$$

Set

$$\mu_{10} = 360^\circ - 4\beta_2 = 111,58416935\dots^\circ.$$

In a rhombus $ABCD$ of side length a with $\angle ABC = \angle CDA = \mu_{10}$ set

$$\mu_{11} = \angle BCD = \angle DAB = 107.33036193\dots^\circ.$$

In an isosceles triangle ABC with $AB = BC = b_1$ and $AC = a$ set

$$\mu_{12} = \angle ABC = 60.84490538\dots^\circ.$$

In a triangle ABC with $AB = b_1$, $BC = b_0$ and $AC = a$ set

$$\mu_{13} = \angle ACB = 86.30970424\dots^\circ.$$

Set

$$\mu_{14} = 360^\circ - 2\beta_2 - \beta_4 - \alpha_3 = 103.78995170\dots^\circ$$

In an isosceles triangle ABC with $AB = BC = a$ and $\angle ABC = \mu_{14}$ set

$$t''_1 = |\angle ABC| = 38.75016462\dots^\circ.$$

References

- [1] C. Bachoc and F. Vallentin, New upper bounds for kissing numbers from semidefinite programming, *J. Amer. Math. Soc.*, **21** (2008), 909–924.
- [2] K. Böröczky and L. Szabó, Arrangements of 13 points on a sphere, in: *Discrete geometry – In honor of W. Kuperberg’s 60th birthday*, (A. Bezdek, ed.), Marcel Dekker (New York–Basel, 2003), 111–184.
- [3] L. Fejes Tóth, On the densest packing of spherical caps, *Amer. Math. Monthly*, **56** (1949), 330–331.
- [4] L. Fejes Tóth, Remarks on a theorem of R. M. Robinson, *Studia Sci. Math. Hungar.*, **4** (1969), 441–445.
- [5] L. Fejes Tóth, Research problem no. 44, *Period. Math. Hungar.*, **20** (1989), 89–91.
- [6] T. C. Hales, A proof of Fejes Tóth’s conjecture on sphere packings with kissing number twelve, eprint arXiv:1209.6043.
- [7] O. R. Musin and A. S. Tarasov, The strong thirteen spheres problem, *Discrete Comput. Geom.*, **48** (2012), 128–141.